

EE-SPX301/401

Light Modulation Effectively Reduces External Light Interference

- Easy adjustment and optical axis monitoring with a Light-ON indicator
- Wide operating voltage range: 5 to 24 VDC
- Amplifier output can be directly connected to a programmable controller (PLC)
- Easy-to-wire connector type
- Convert to PNP output with EE-2001 conversion connector



Ordering Information

Appearance	Sensing method	Slot width	Slot depth	Output configuration	Weight	Part number
	Slot	3.6 mm	9 mm	Dark-ON	Approx. 2.6 g	EE-SPX301
				Light -ON		EE-SPX401

■ ACCESSORIES

Name	Part number
Solder connector	EE-1002
Connector with 1 m cable	EE-1003
Connector holder for EE-1003	EE-1003A

Specifications

■ RATINGS

Model		Transmissive type	
		EE-SPX301	EE-SPX401
Supply voltage		5 to 24 VDC $\pm 10\%$, ripple (p-p): 5% max.	
Current consumption		Average: 15 mA max.; Peak: 50 mA max.	
Standard reference object		Opaque, 0.5 x 1 mm min.	
Differential distance		0.05 mm max.	
Control output		At 5 to 24 VDC: 80 mA load current (I_C) with a residual voltage of 1.0 V max. When driving TTL: 10 mA load current (I_C) with a residual voltage of 0.4 V max.	
Output configuration	Transistor on output stage without detecting object	OFF	ON
	Transistor on output stage with detecting object	ON	OFF
Indicator (See note 1.)	Without detecting object	ON	
	With detecting object	OFF	
Response frequency (See note 2.)		500 Hz	
Light source		GaAs infrared LED (pulse modulated) with a wavelength of 940 nm	
Receiver		Si photo-diode with a sensing wavelength of 850 nm max.	
Connecting method		EE-1002/1003 Connectors; solder terminals/cordset	

Note: 1. The indicator is a GaP red LED (peak emission wavelength: 700 nm).

2. The response frequency was measured by detecting the following disks rotating.

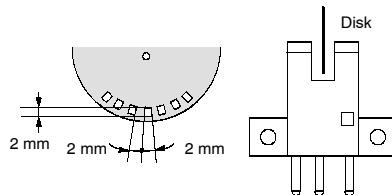

■ CHARACTERISTICS

Ambient illumination		Sensing face: fluorescent light/incandescent light: 3,000 lx max.
Enclosure ratings		IP50
Ambient temperature	Operating	-10°C to 55°C (14°F to 131°F)
	Storage	-25°C to 65°C (-13°F to 149°F)
Ambient humidity	Operating	35% to 85%
	Storage	35% to 95%
Vibration resistance		Destruction: 10 to 55 Hz, 1.5-mm double amplitude for 2 hrs each in X, Y, and Z directions
Shock resistance		Destruction: 500 m/s ² (approx. 50G's) for 3 times each in X, Y, and Z directions
Cable length		2 m max. by AWG22

Engineering Data

SENSING POSITION CHARACTERISTICS

EE-SPX301 (Typical)

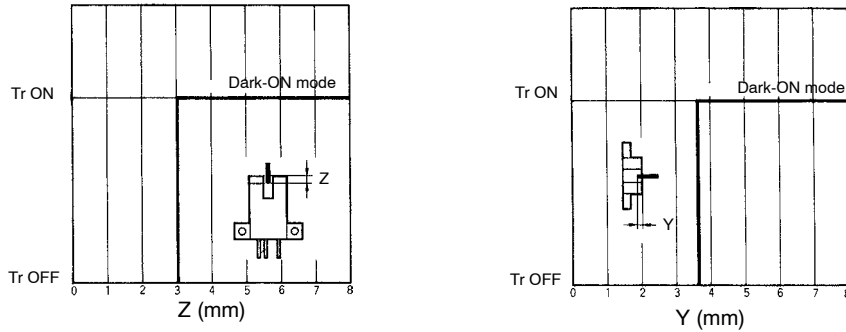

Note: The sensing position characteristics of the EE-SPX401 are opposite those of the EE-SPX301.

Operation

INTERNAL/EXTERNAL CIRCUIT DIAGRAM

Light-ON/Dark-ON

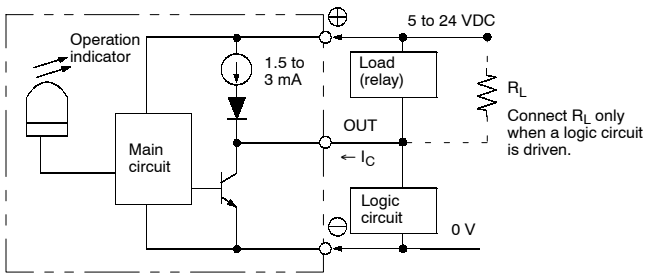

TIMING CHART

Light-ON

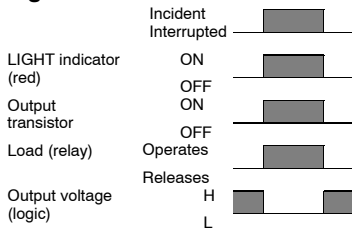

Dark-ON

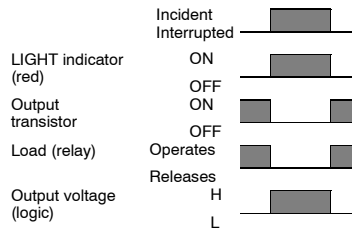

Dimensions

Unit: mm (inch)

EE-SPX301, EE-SPX401

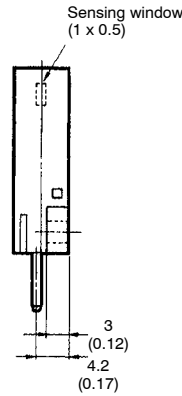
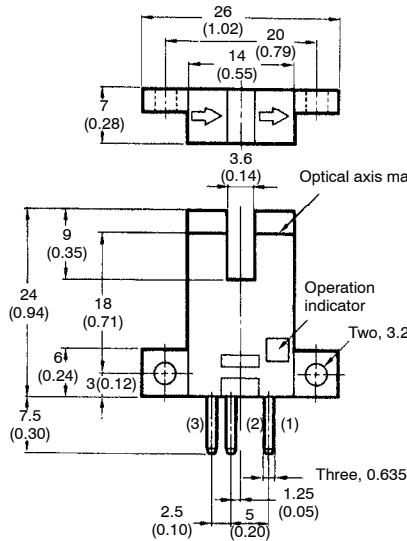
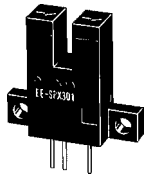

Terminal Arrangement

(1)	⊕	V _{CC}
(2)	OUT	OUTPUT
(3)	⊖	GND (0 V)

EE-1002 SOLDER CONNECTOR

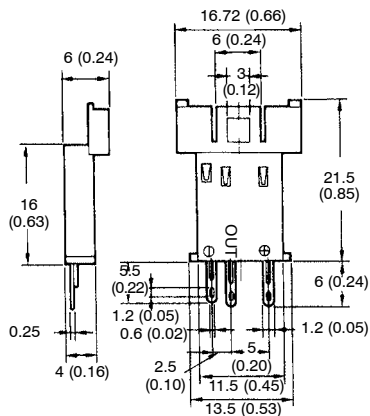
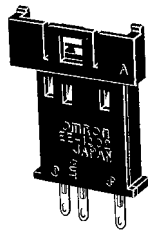

EE-1003 CONNECTOR WITH CABLE

The connector comes with a 1-m cable.

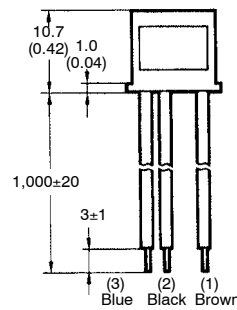
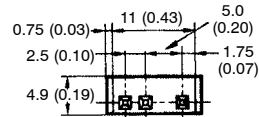

Terminal Arrangement

(1)	⊕	V _{CC}
(2)	OUT	OUTPUT
(3)	⊖	GND (0 V)

EE-SP_+EE-1003

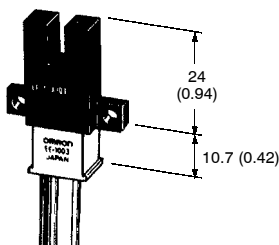

EE-1003A CONNECTOR HOLDER

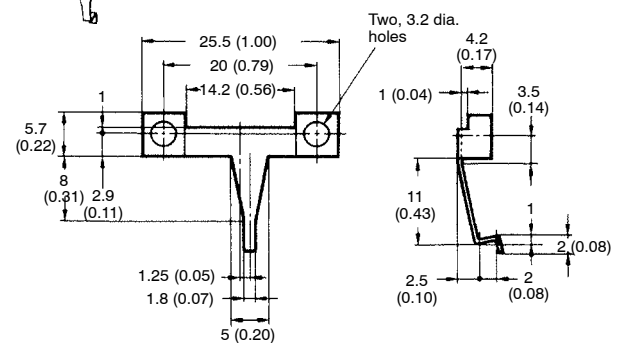
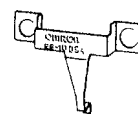

Precautions

Refer to the Technical Information Section for general precautions.

■ WIRING

A cable with a thickness of 0.3 mm² min. or AWG22 and a length of 2 m max. must be connected to the output terminals.

To use a cable longer than 2 m, attach a capacitor with a capacitance of approximately 10 µF to the wires, as shown below. The distance between the terminal and the capacitor must be 2 m or less:

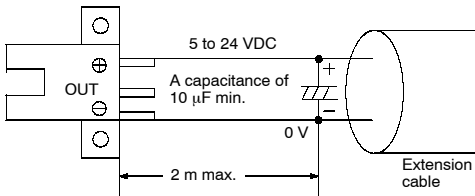

Do not solder the cable to the connectors. Use the EE-1002 Connector or EE-1003 Connector (with a 1-m cable attached) to connect the cable to the output terminals.

Use the EE1003A Connector Holder to prevent accidental disconnection of the EE-1003 Connector from the EE-SPX301/401 Photomicrosensor.

Do not impose excessive force on the terminals (refer to the diagram below). Excess force will damage the terminals.

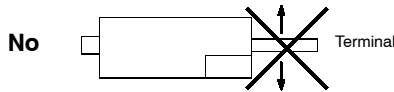

Do not disconnect the EE-1002 or EE-1003 Connector from the photomicrosensor when power is supplied to the photomicrosensor, or the photomicrosensor could be damaged.

If the metal mounting base is subjected to inductive electrical noise, the photomicrosensor can be activated accidentally. If noise is a problem, take the following precautions:

- Connect the negative terminal to the mounting base, so there will be no difference in electric potential between the photomicrosensor and mounting base.
- Connect the negative terminal to the mounting base through a 0.47-µF capacitor.
- 3. Insert a plastic insulating plate with a thickness of approximately 10 mm between the photomicrosensor and mounting base.

Wire as shown by the following illustration to connect a small inductive load (a relay for example) to the photomicrosensor. A diode must be connected parallel to the relay to absorb the reverse voltage.

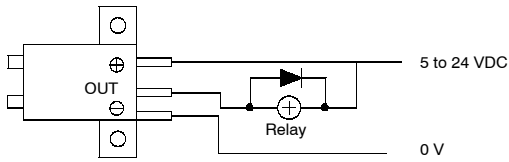

■ POWER SUPPLY

When using a standard switching regulator, ground the FG and G terminal, so the photomicrosensor will be in a stable operating condition.

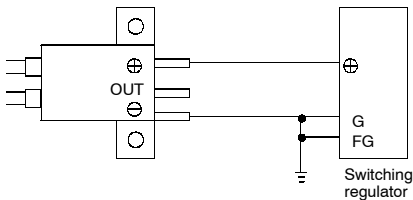

NOTE: DIMENSIONS SHOWN ARE IN MILLIMETERS. To convert millimeters to inches divide by 25.4.

OMRON[®]

OMRON ELECTRONICS LLC

One East Commerce Drive
Schaumburg, IL 60173

1-800-55-OMRON

OMRON ON-LINE

Global - <http://www.omron.com>

USA - <http://www.omron.com/oei>

Canada - <http://www.omron.com/oci>

OMRON CANADA, INC.

885 Milner Avenue
Toronto, Ontario M1B 5V8

416-286-6465